

Dr.-Ing. Andreas Wohlfeld

**Lead Modeling Expert
OPC UA for Machine Tools**

Lead Architect Smart Factory / Production Solutions
TRUMPF Werkzeugmaschinen GmbH & Co. KG



What is OPC UA for Machine Tools (UA4MT)?

There's no better connection than that of a common language – also for machine (tools).

- UA4MT enables machine tools and peripherals to connect to customer-specific IT ecosystems, inside or outside the production environment, via an open, universal interface – easy, secure, and seamless.
- UA4MT's core feature is standardized **semantics**, embedded in an **information model** based on the **open communication standard OPC UA**.
- UA4MT supports **specific extensions** for manufacturers and customers of machine tools.
- UA4MT's aim is to establish a **worldwide standard** for the connectivity of machine tools.

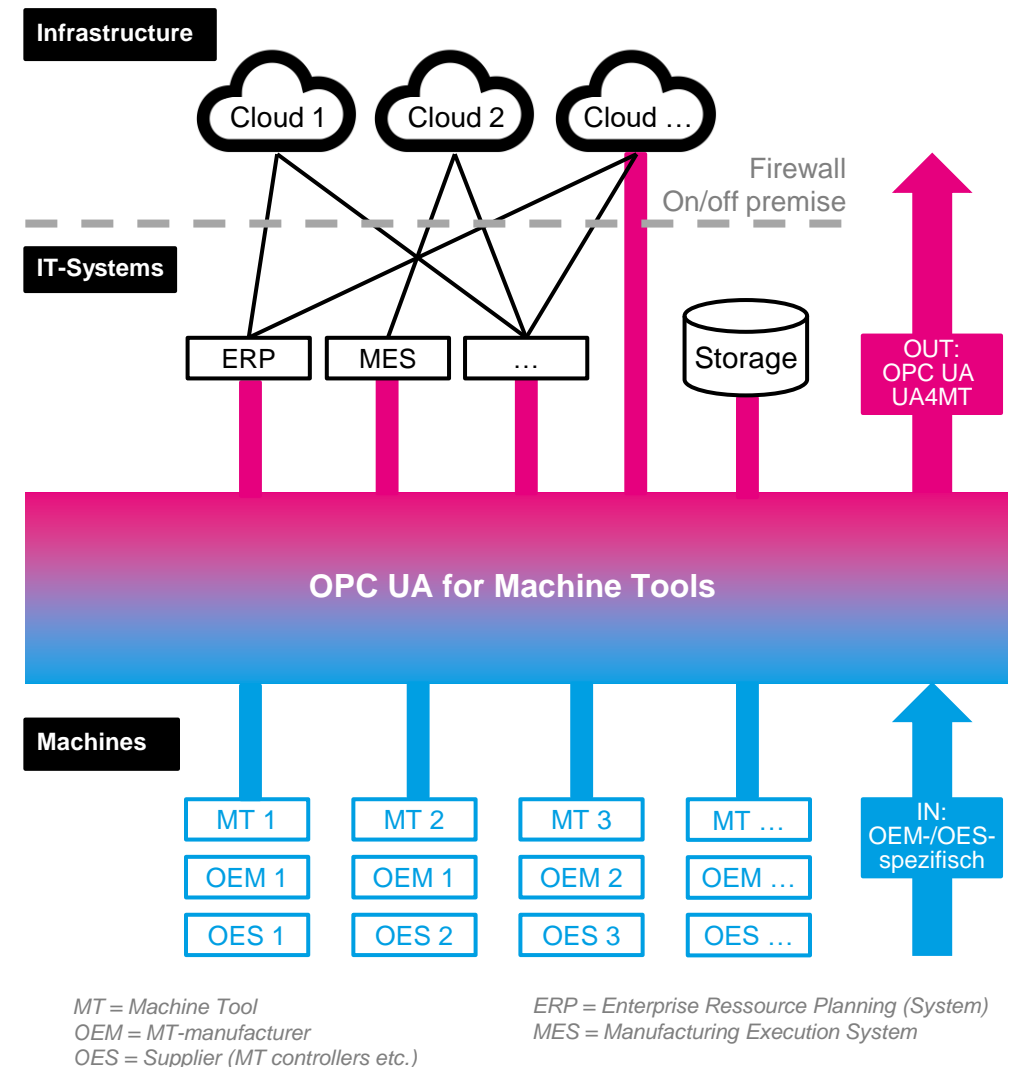

How it started

- In 2017 ten companies mandated by the board of the VDW – the German Machine Tools Builders' Association – started the initiative **Connectivity for Industry 4.0 for machine tools**
- They started the development of an **OPC UA companion specification** and **further standardization efforts** for the machine tool industry and the brand to **umati** to promote their activities.

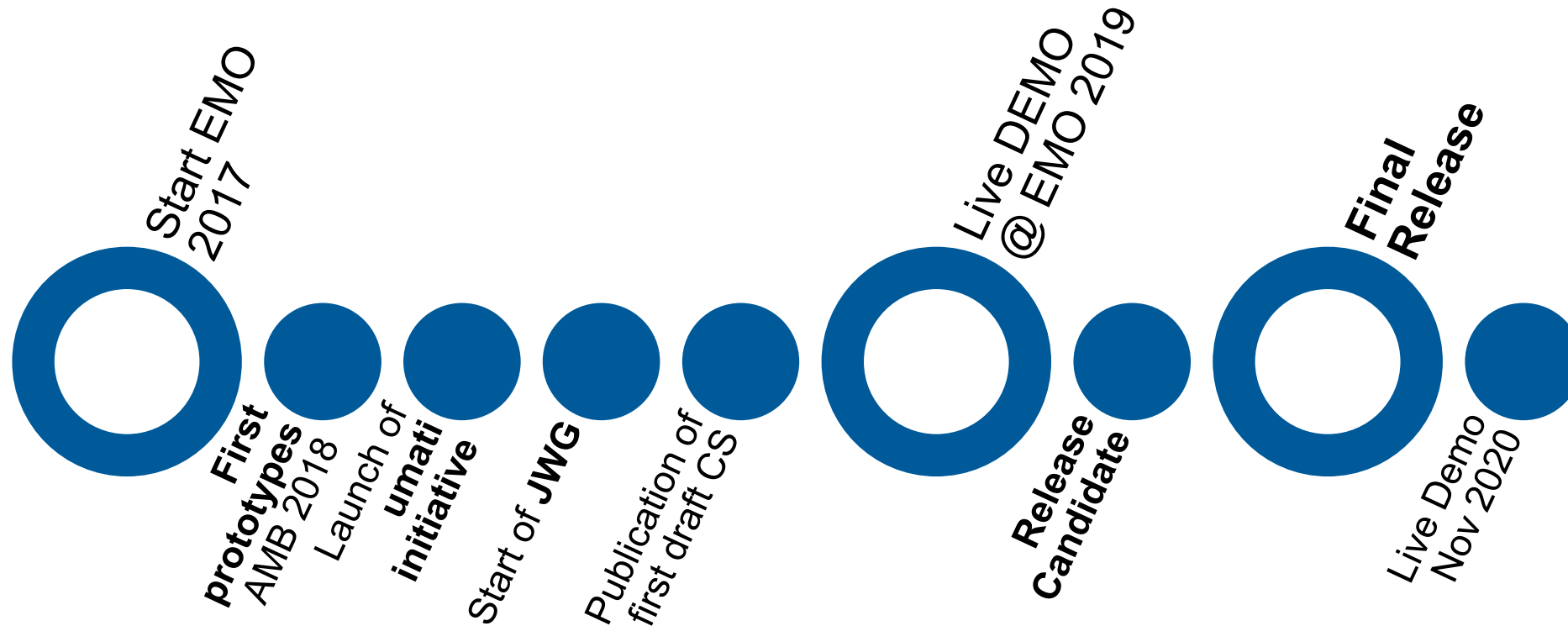

Machine Tool Technologies



- First part is technology agnostic
- Applicable for all types of machine tools
- Core partners selected to have all relevant technologies in the group from the beginning

core partners



DMG MORI



HELLER



ePfiffner

LIEBHERR



OPC Foundation Joint Working Group



- 2019-02-22: Kickoff Meeting
- Many web and F2F meetings with average 50+ participants
- 85 member companies
- 190 registered persons



of companies per country

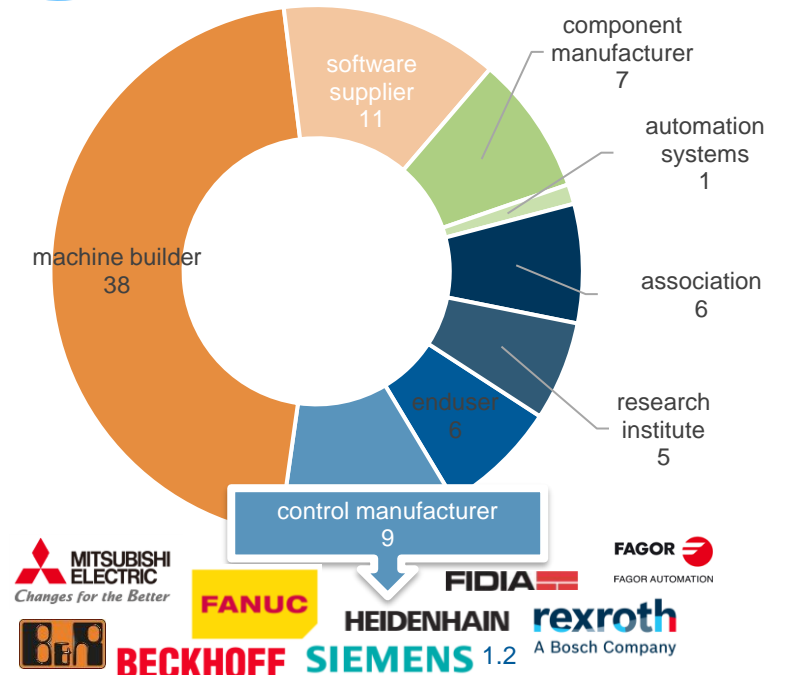
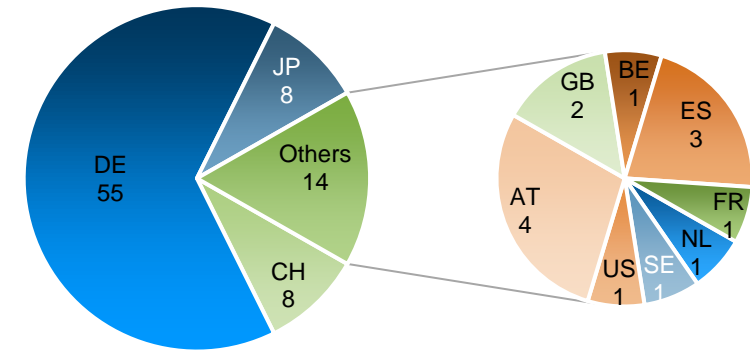

Networking and harmonization



- The VDW and the working group is synchronized with the activities of the respective associations
- We are partnering with consortiums from Japan, China and Switzerland
- We are harmonizing our activities and contribute work to the OPC UA for Machinery as well as the OPC-Foundation harmonization working group

association partners

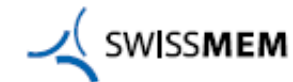

consortium partners



ProdNet

- Plugfest – connect machines based on release candidate – End August 2020
- Release of the final specification September 2020
- **Virtual showcase – September/October 2020**
- Start work on next parts
- Contribute to work of the OPC UA for Machinery working group

Change of Scope for umati – Past

The brand *umati* was given a much broader scope around HMI2020

- OPC UA Companion Specifications can be used world wide for free
- umati is a „marketing/quality assurance club“ independent of a single specification
- umati could integrate a wide variety of CSs

Machinery: must use „umati accredited“ OPC UA CSs

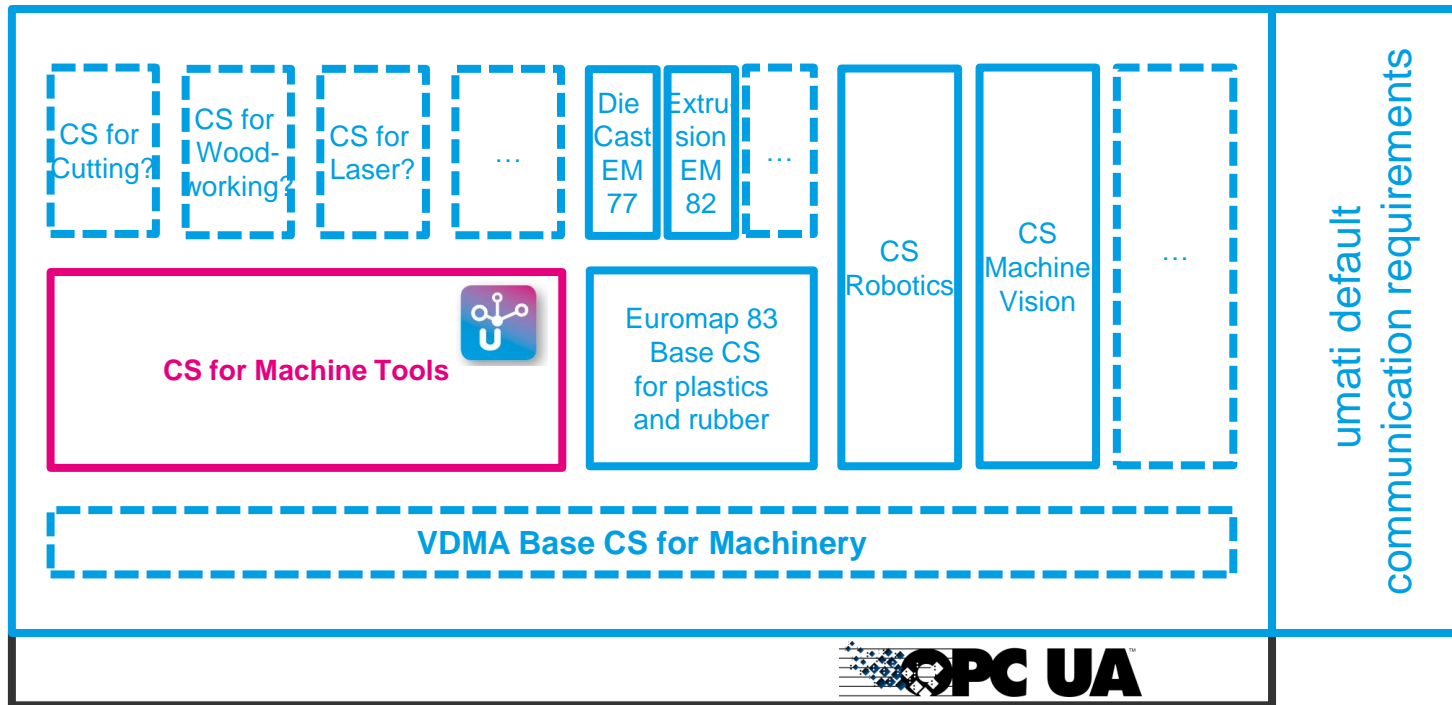

Software: must be able to load „umati accredited“ OPC UA CSs

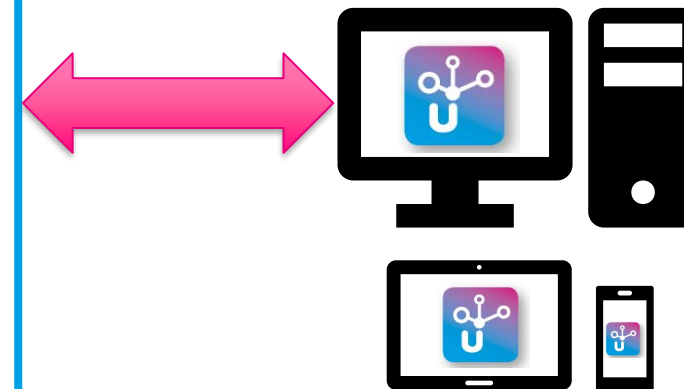

Change of Scope for umati – Present

The brand *umati* was given a much broader scope around HMI2020

- OPC UA Companion Specifications can be used world wide for free
- umati is a „marketing/quality assurance club“ independent of a single specification
- umati could integrate a wide variety of CSs

Machinery: must use „umati accredited“ OPC UA CSs

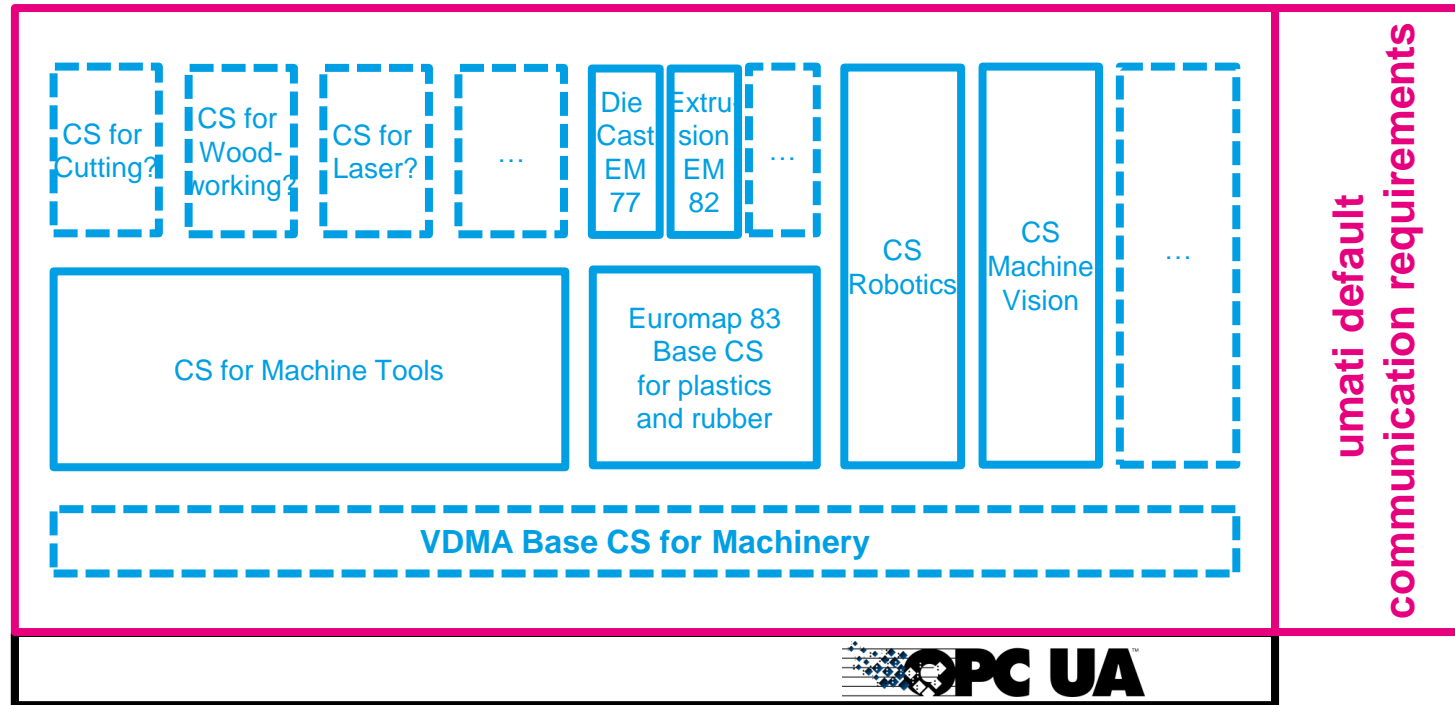

Software: must be able to load „umati accredited“ OPC UA CSs

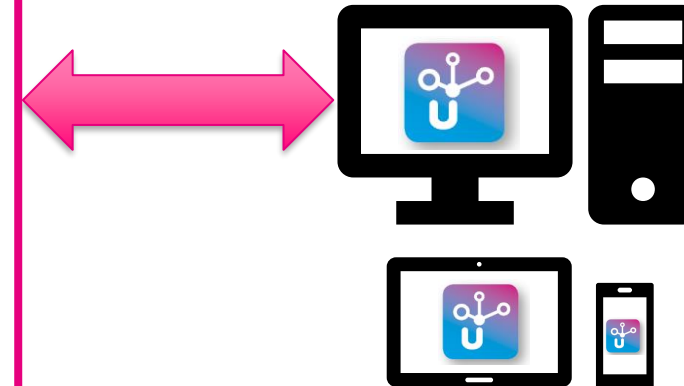

Inheritance of Types and increasing specificity of specifications

The brand *umati* was given a much broader scope around HMI2020

- OPC UA Companion Specifications can be used world wide for free
- *umati* is a „marketing/quality assurance club“ independent of a single specification
- *umati* could integrate a wide variety of CSs

Machinery: must use „umati accredited“ OPC UA CSs

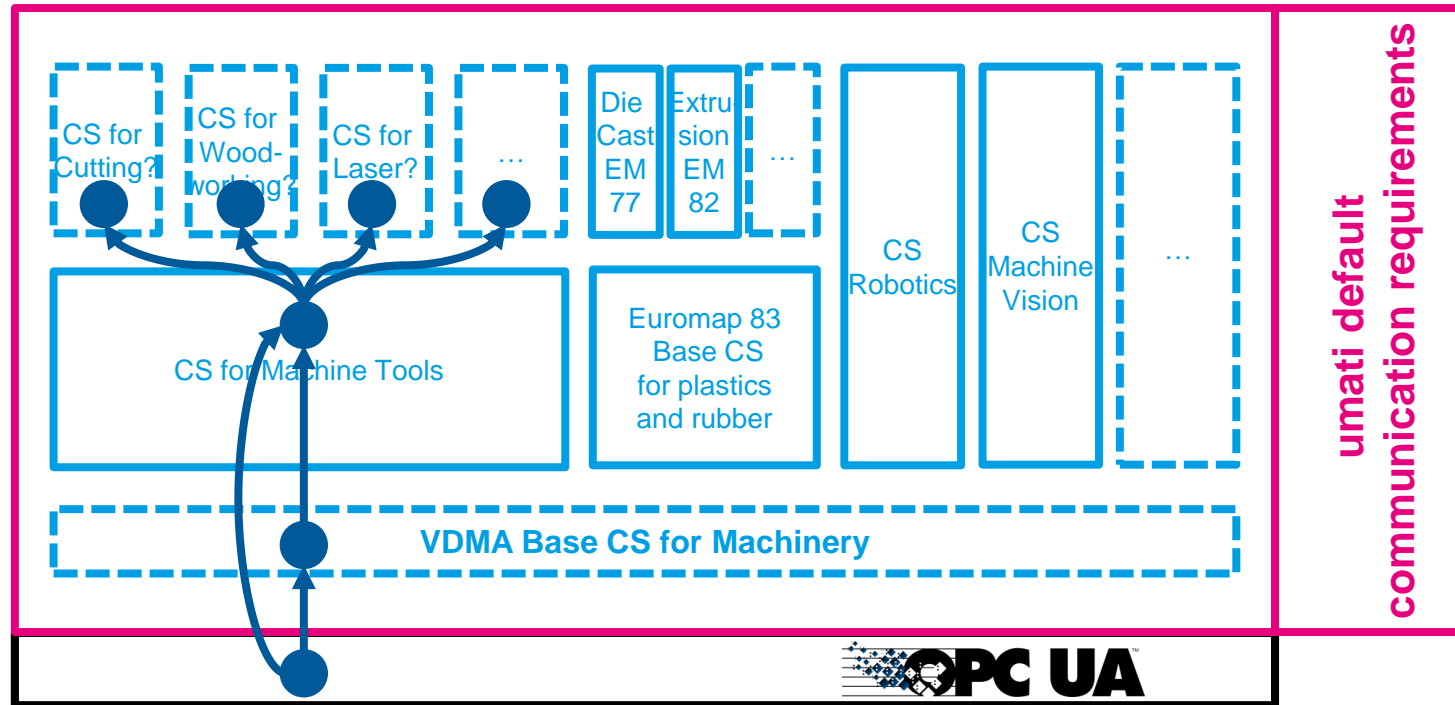

Software: must be able to load „umati accredited“ OPC UA CSs

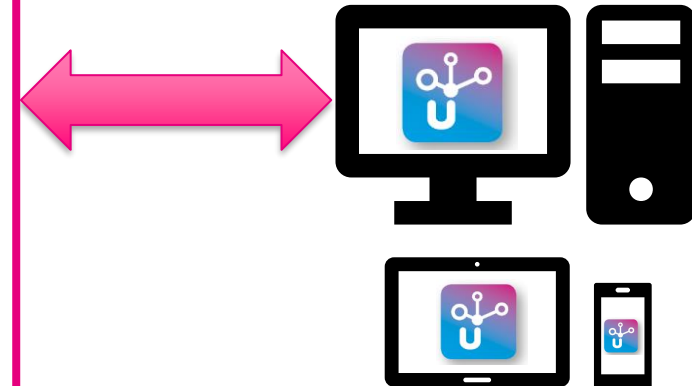

Active Facilitation of Harmonization – Adoption of Types in Base Specs



The brand *umati* was given a much broader scope around HMI2020

- OPC UA Companion Specifications can be used world wide for free
- *umati* is a „marketing/quality assurance club“ independent of a single specification
- *umati* could integrate a wide variety of CSs

Machinery: must use „umati accredited“ OPC UA CSs



Software: must be able to load „umati accredited“ OPC UA CSs

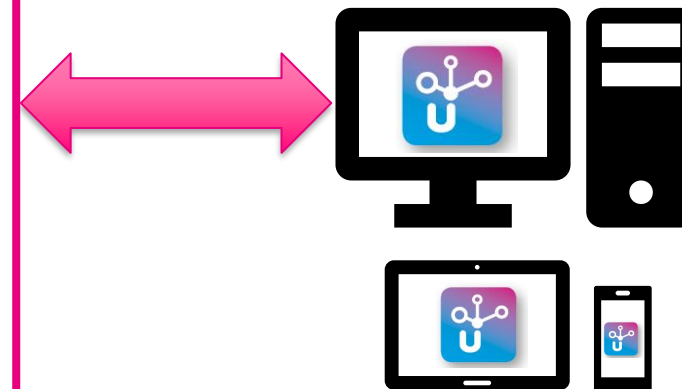
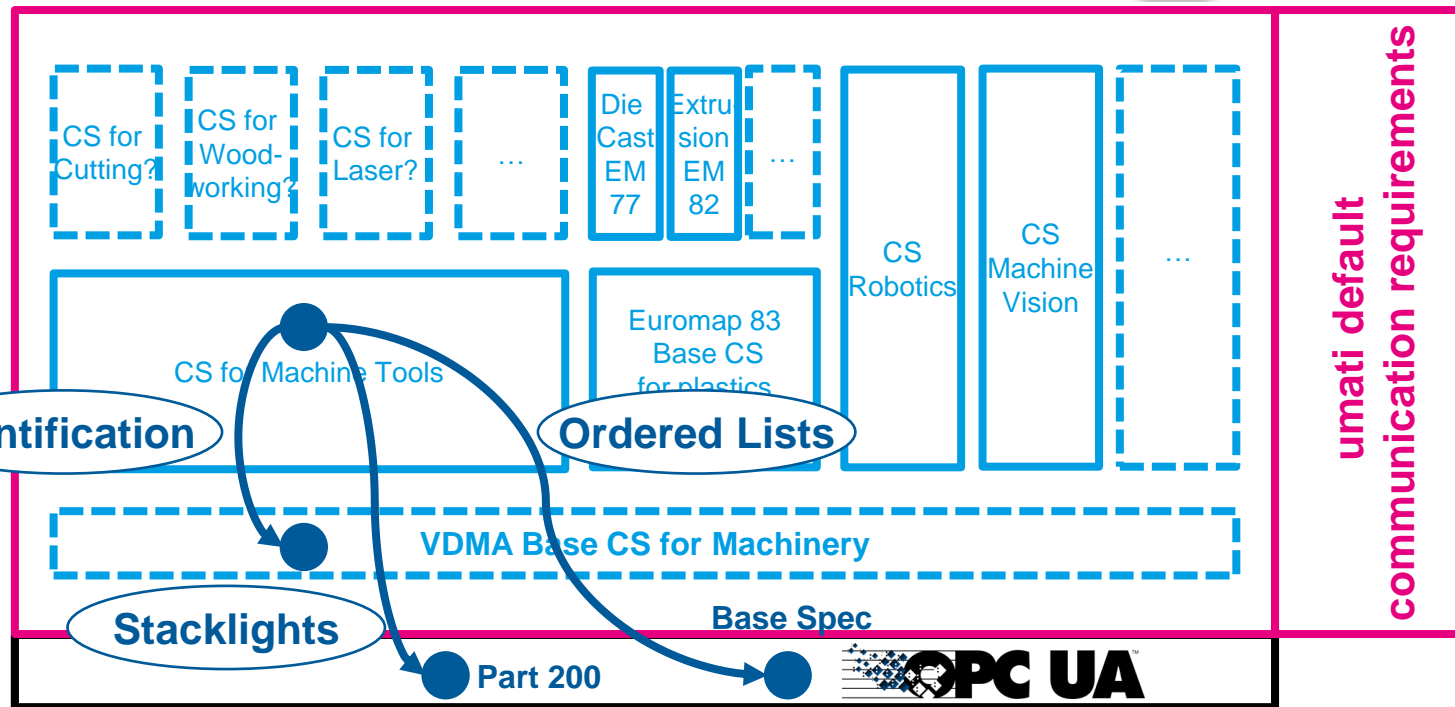



Tonja Heinemann, M.Sc.

CS Editor and Modelling expert

ISW University of Stuttgart

Machine Tools Information Model

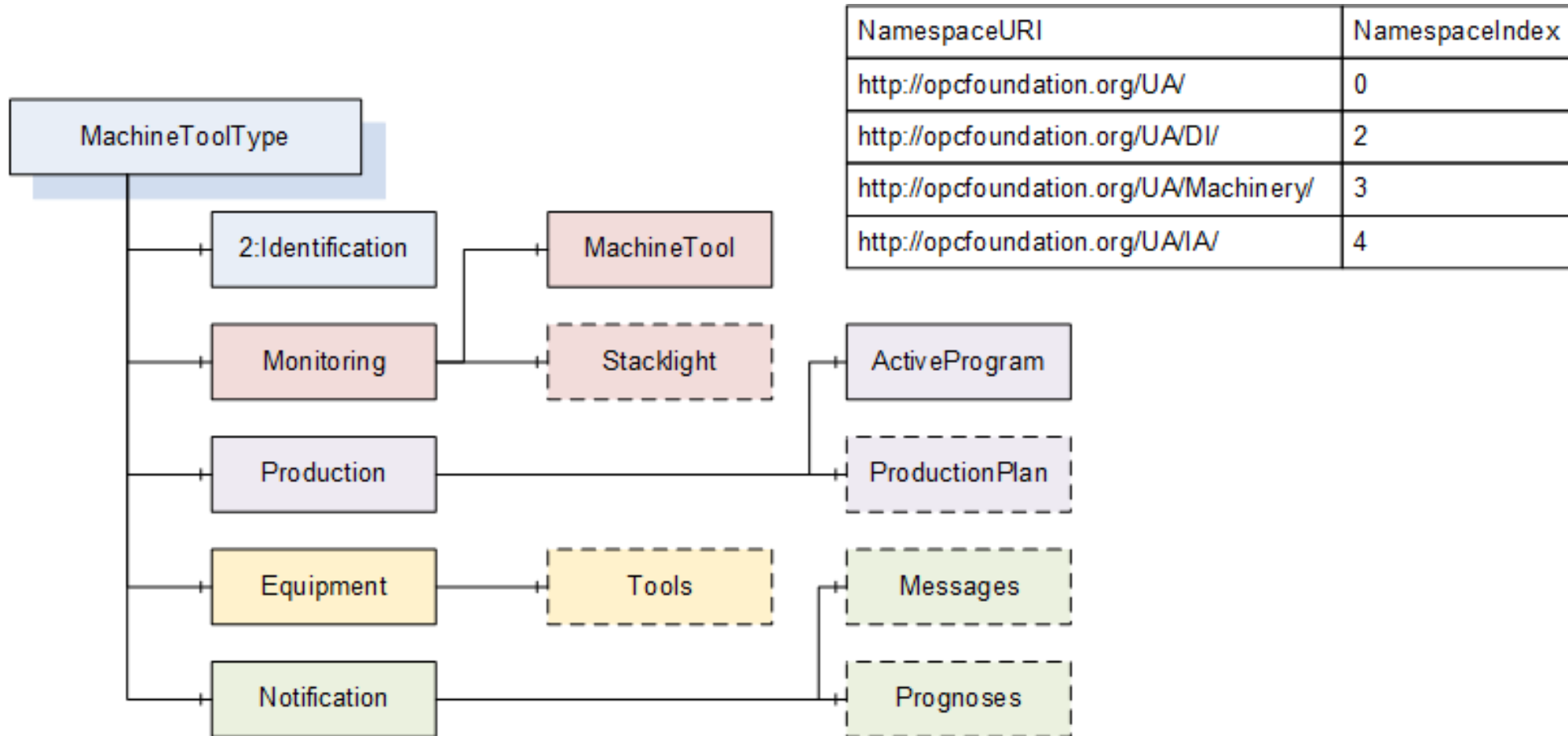

Identification

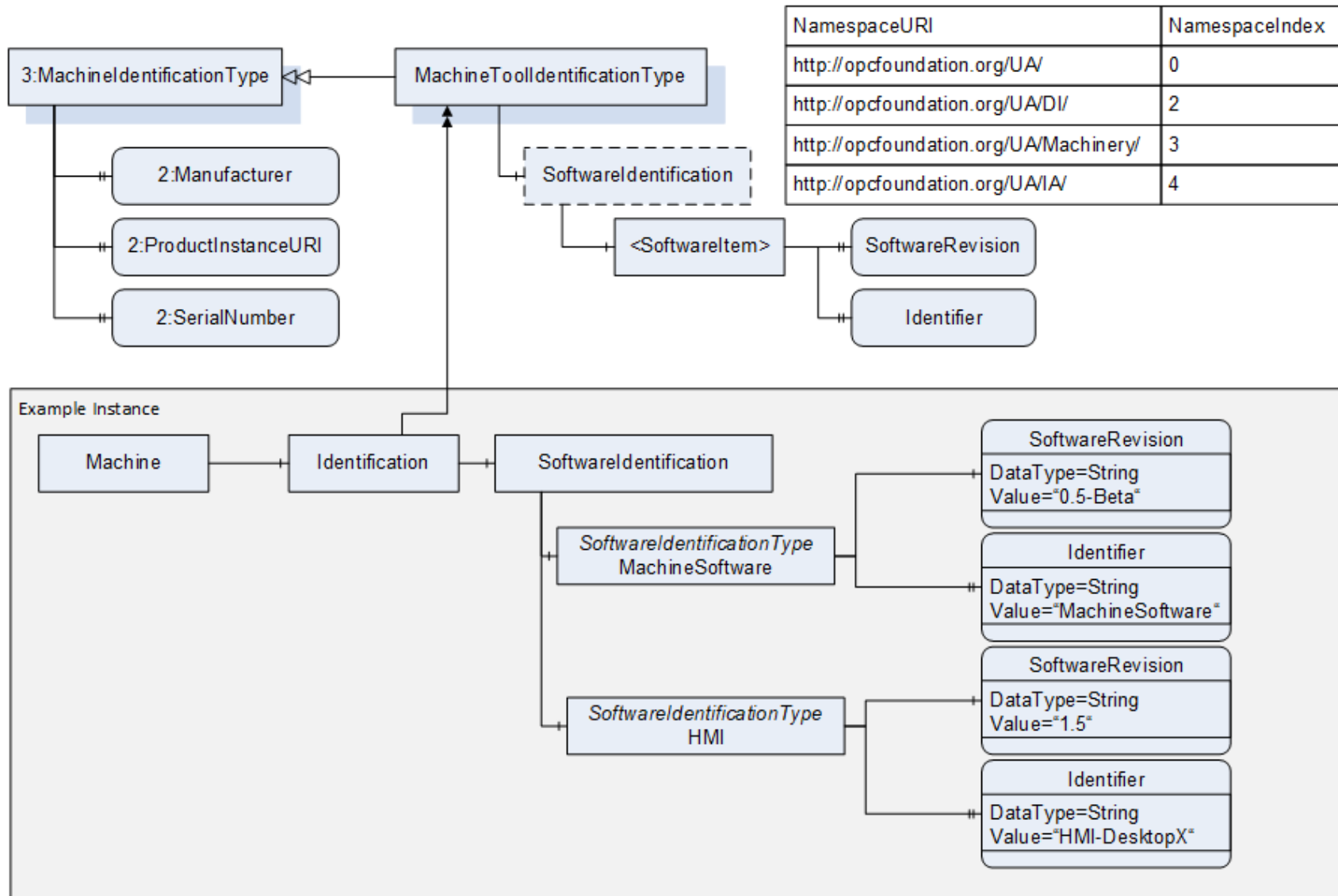

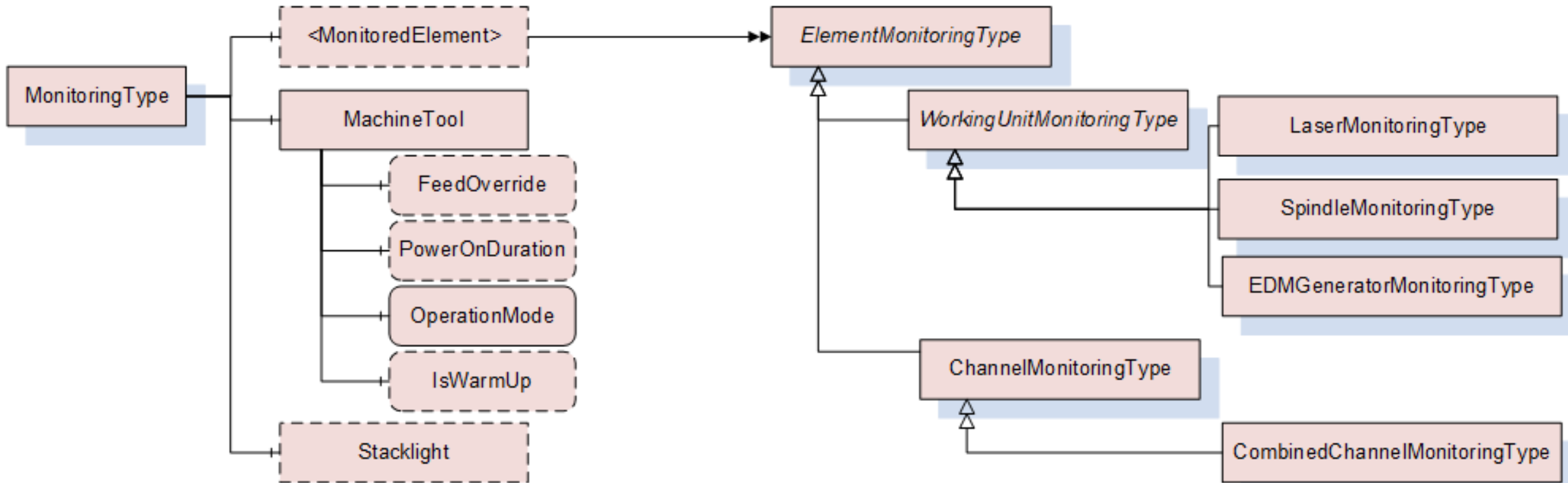

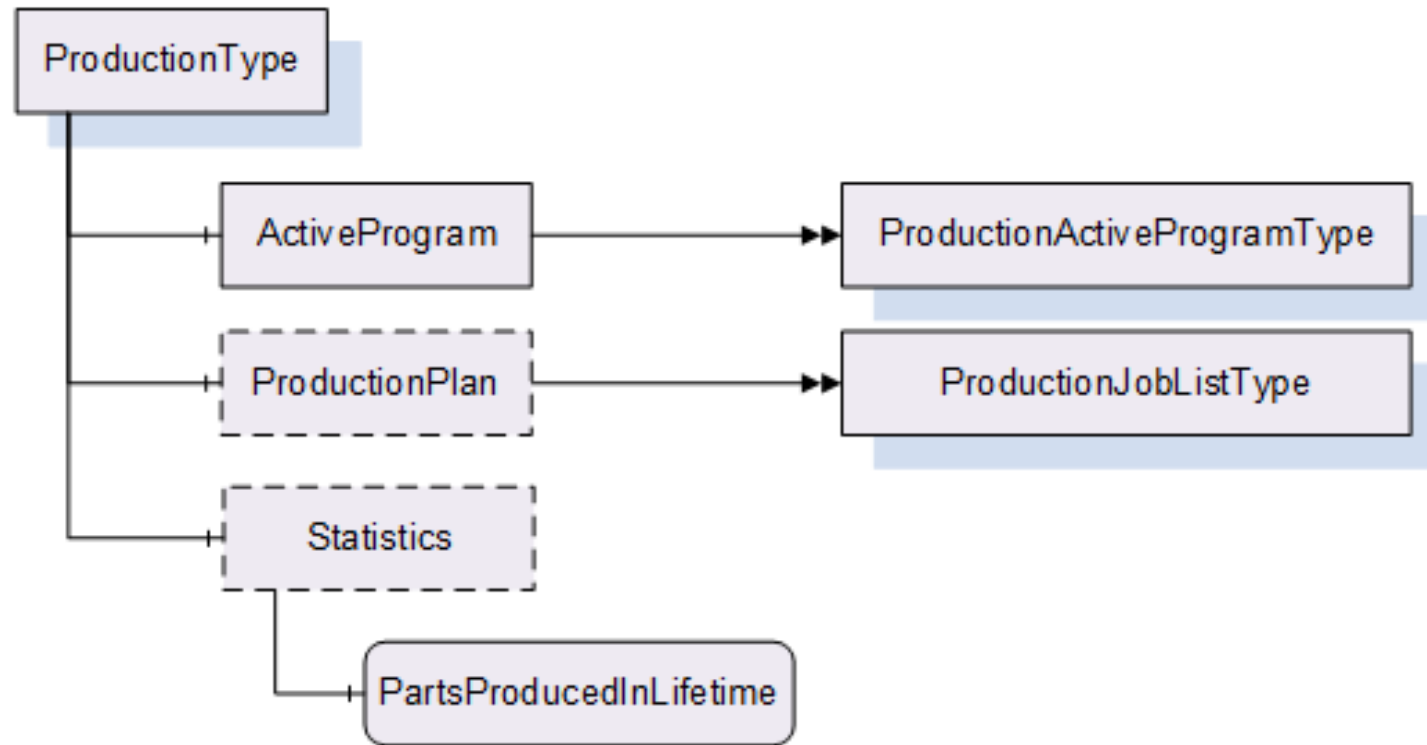

ProductionJobListType (ProductionPlan)

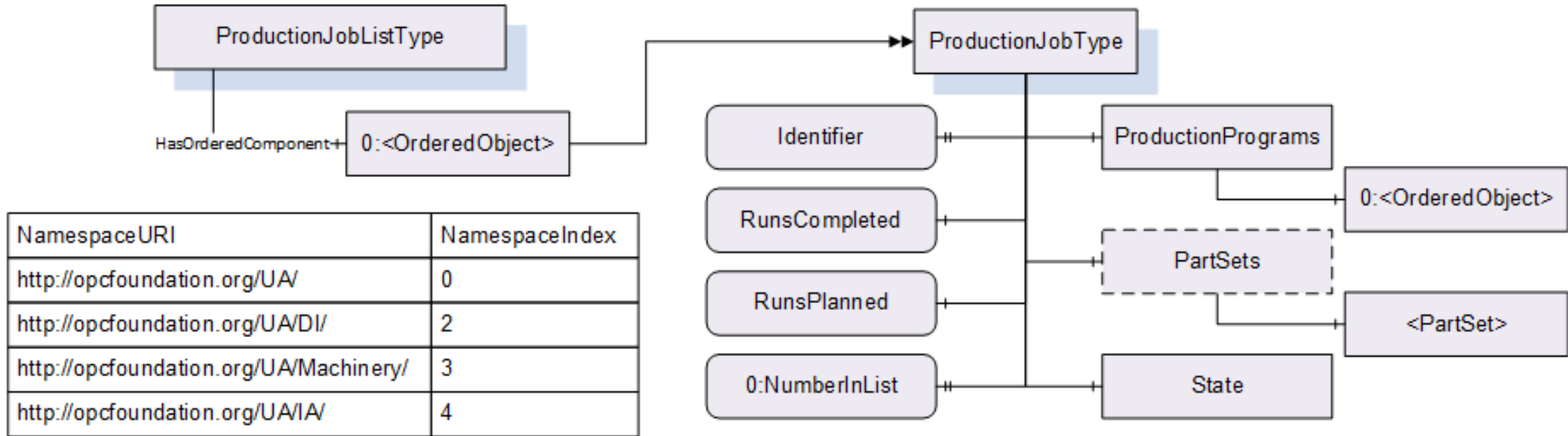

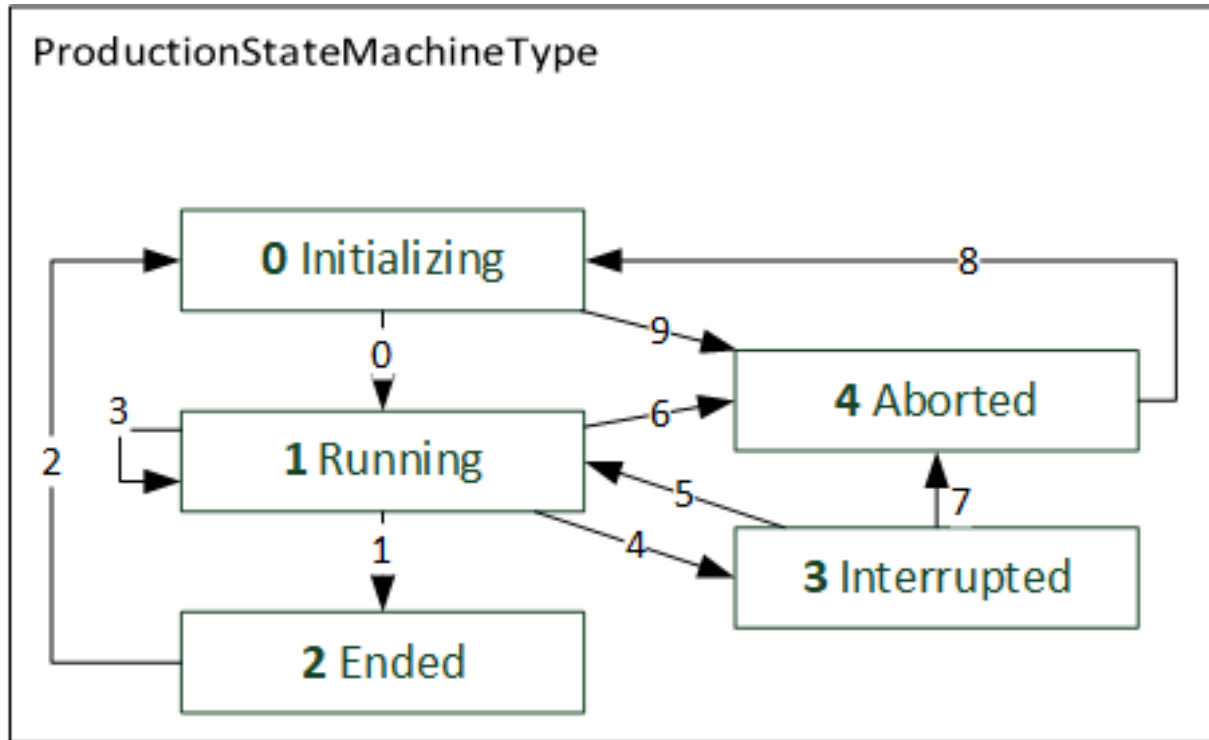

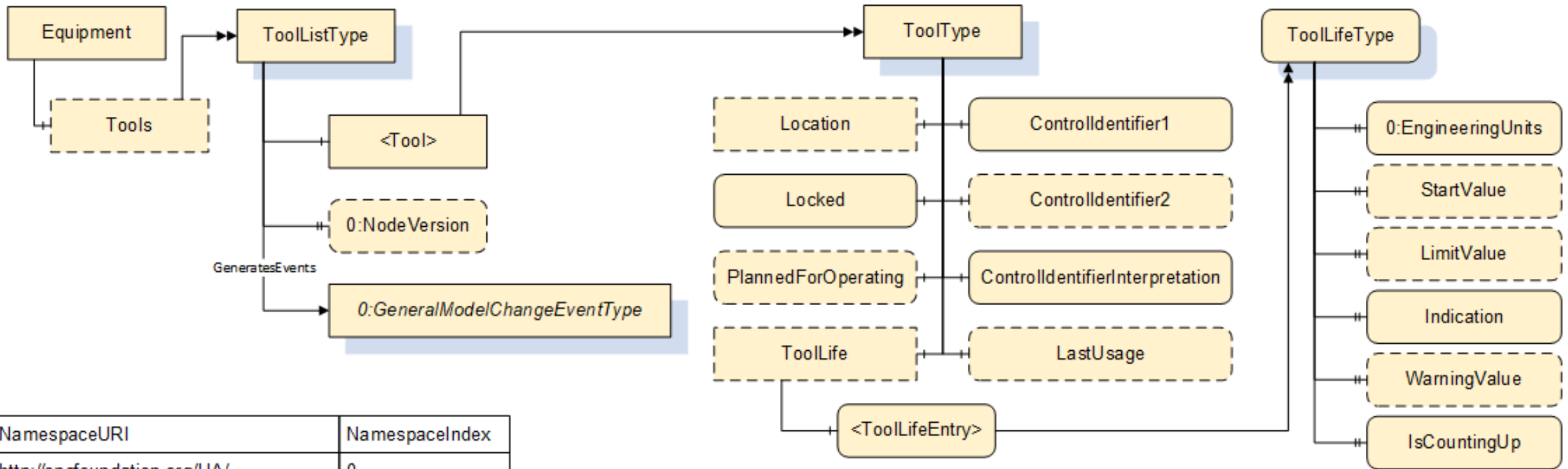

| NamespaceURI | NamespaceIndex |
|--|----------------|
| http://opcfoundation.org/UA/ | 0 |
| http://opcfoundation.org/UA/DI/ | 2 |
| http://opcfoundation.org/UA/Machinery/ | 3 |
| http://opcfoundation.org/UA/IA/ | 4 |

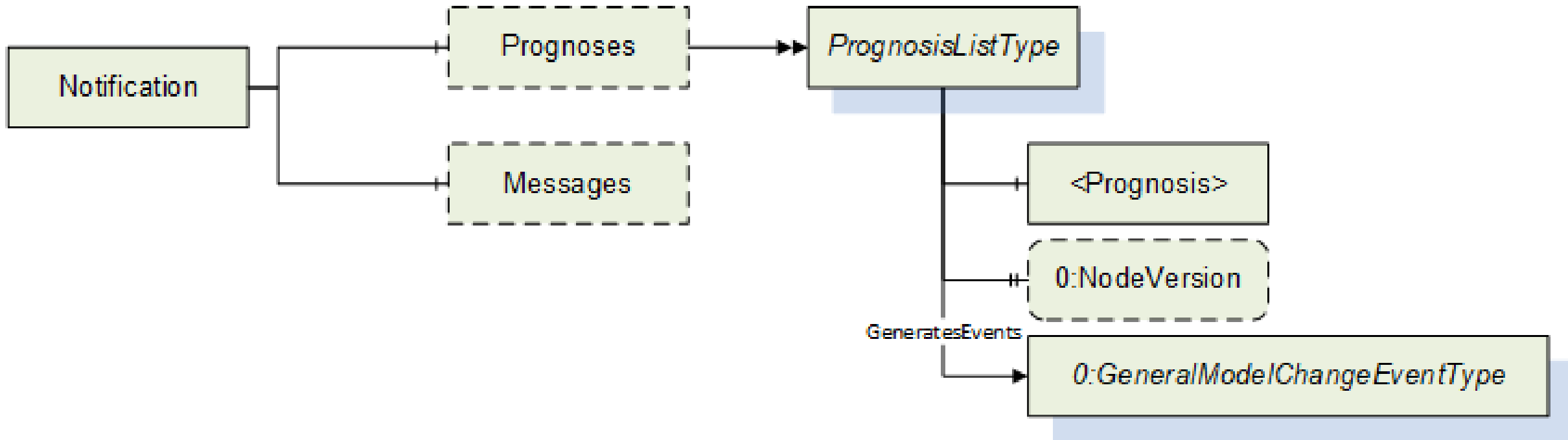

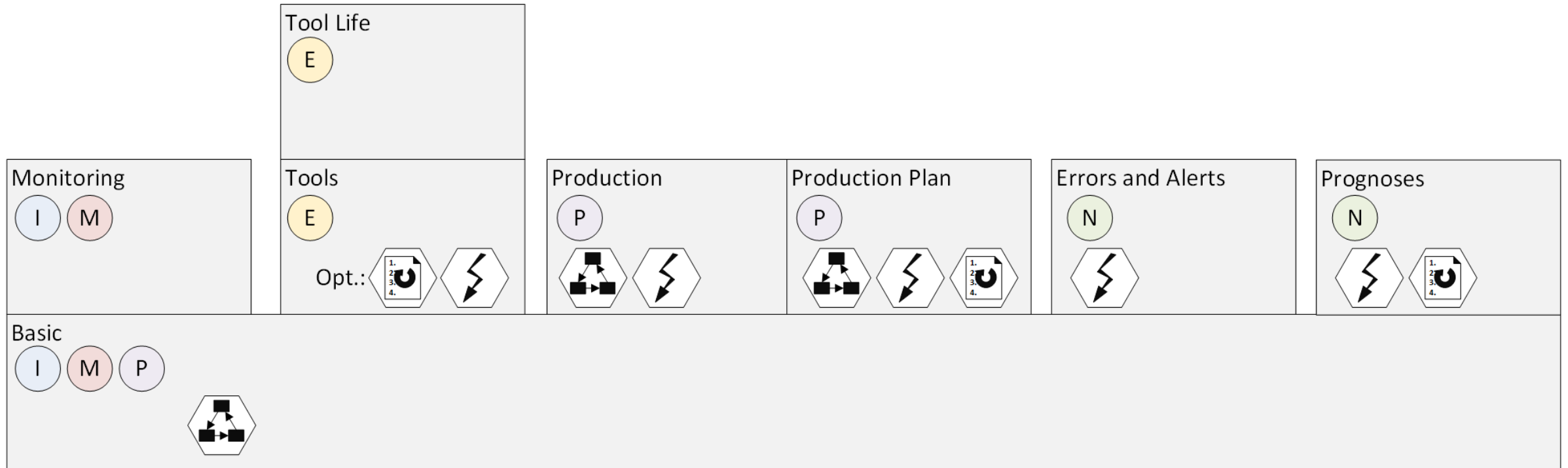

- Identification
- Monitoring
- Production
- Notification
- Equipment
- State Machine
- OPC UA Events
- Dynamic Lists

Facets – AddressSpace View

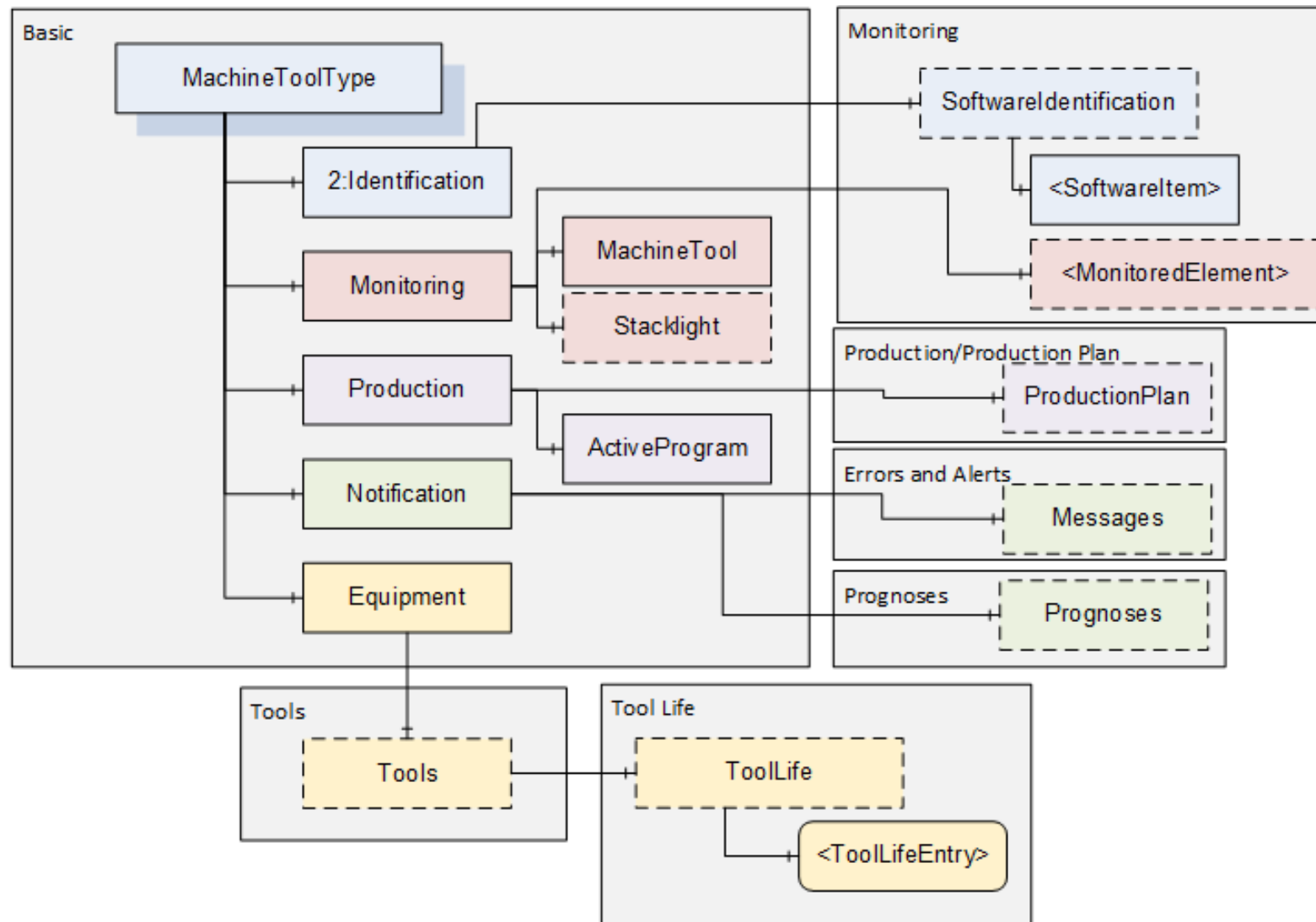

Thank you
for your attention!

For further information please contact: Goetz Goerisch g.goerisch@vdw.de

